

VELUX®

VELUX ELECTRIC FMK / FMG

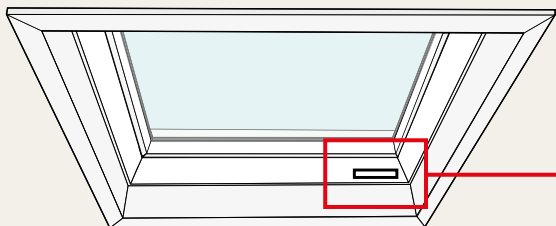

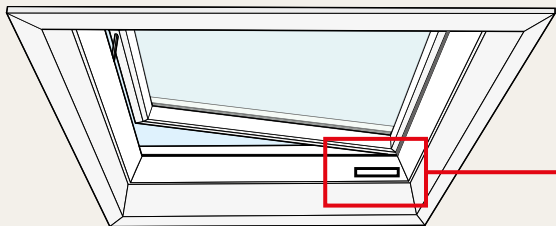

CVP



**Pages
4-22**

CFP



**Pages
24-39**

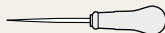
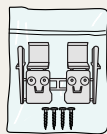
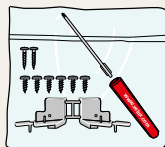
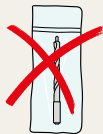
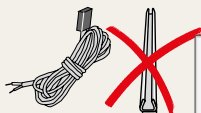
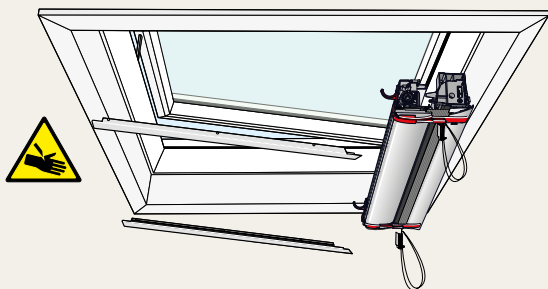

1

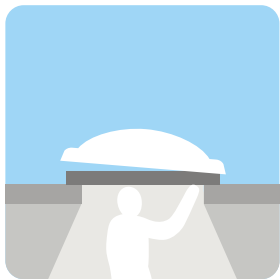
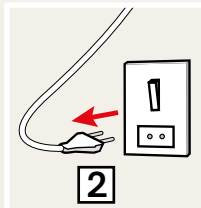
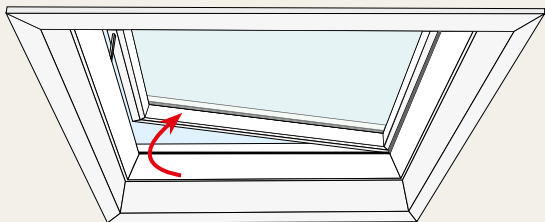

2

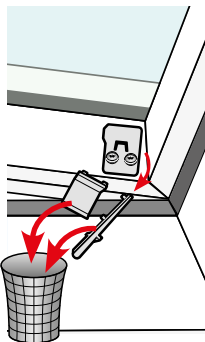
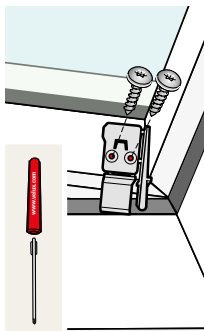
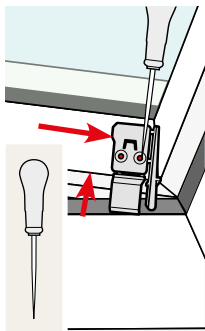
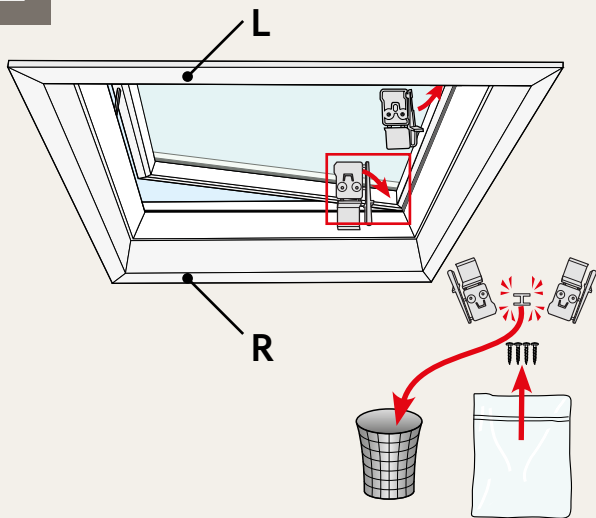

3

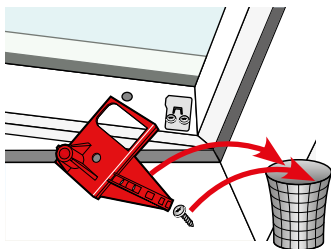
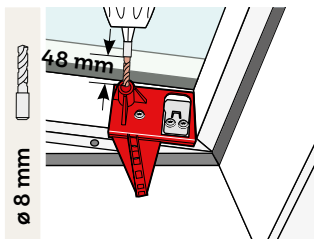
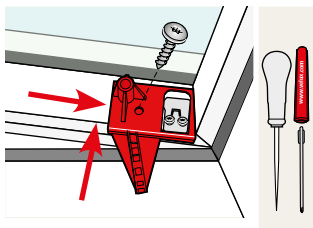
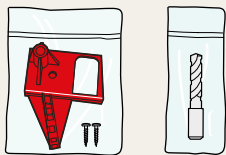
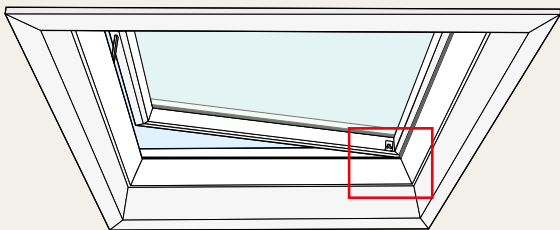

4

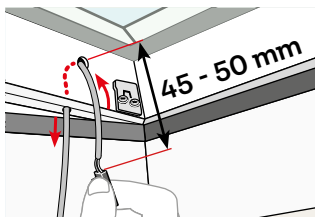
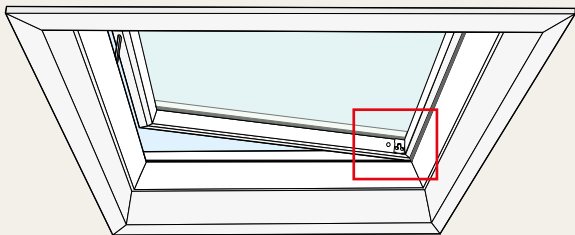

5

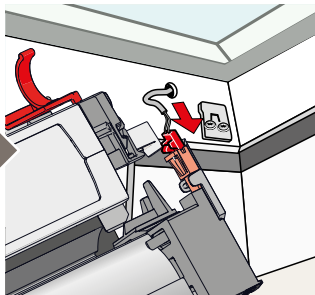
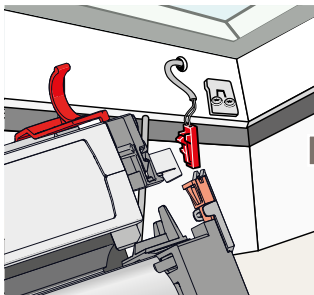
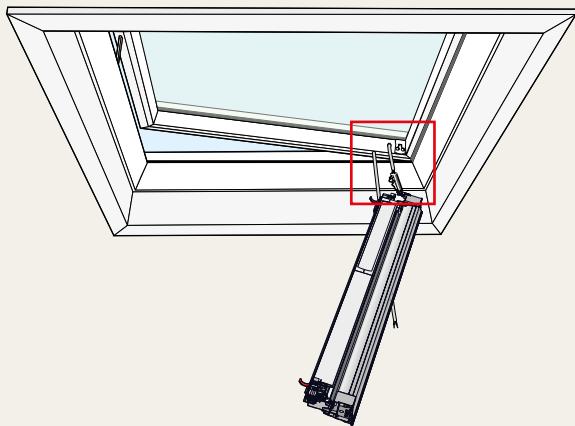

6

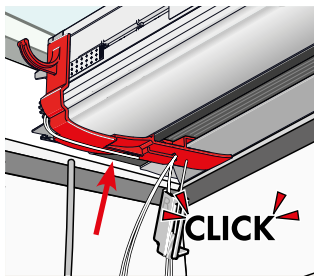
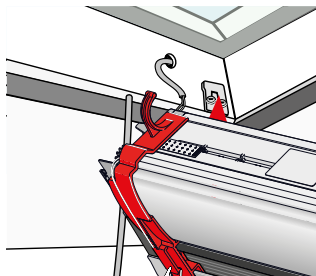
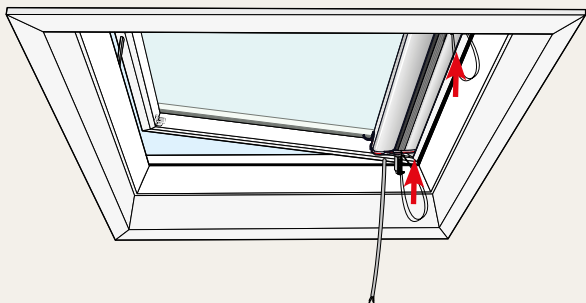

7

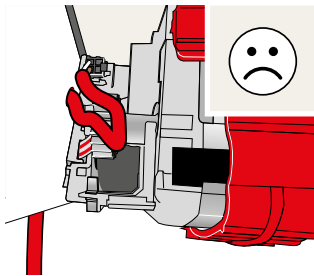
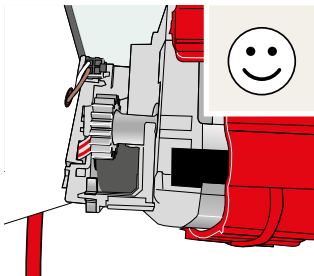
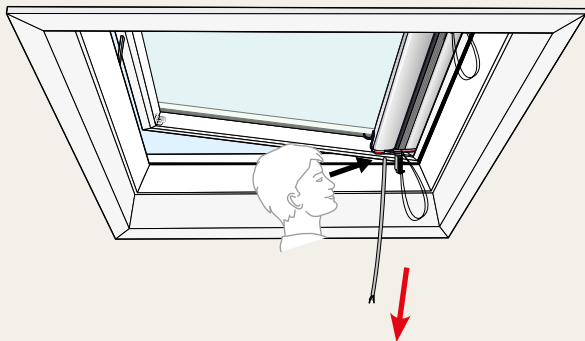

8

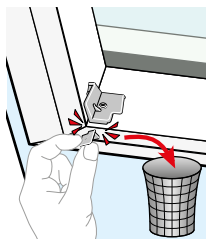
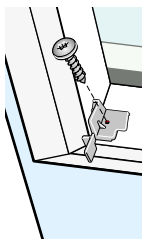
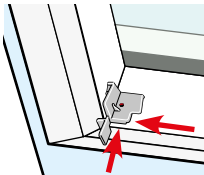
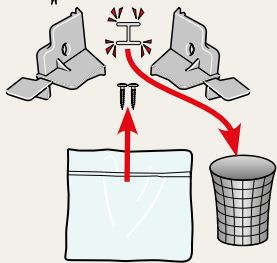
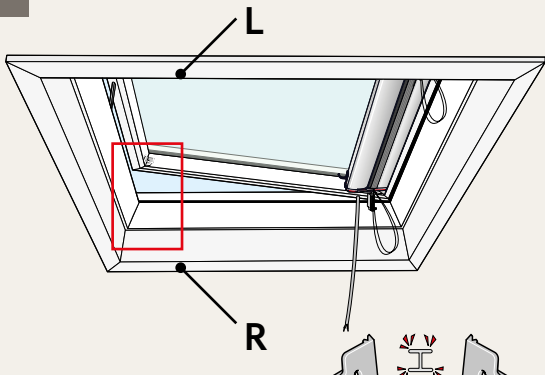

9

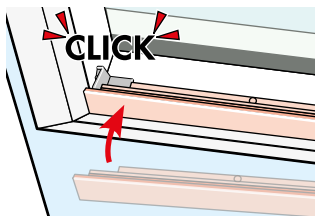
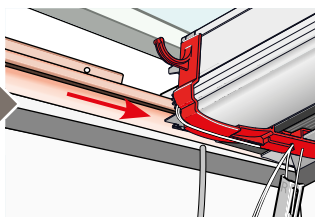
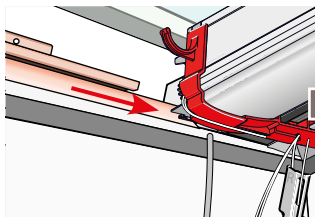
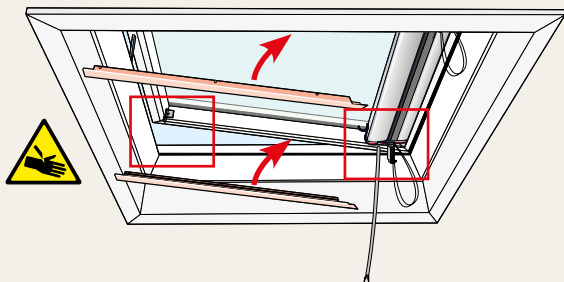

10

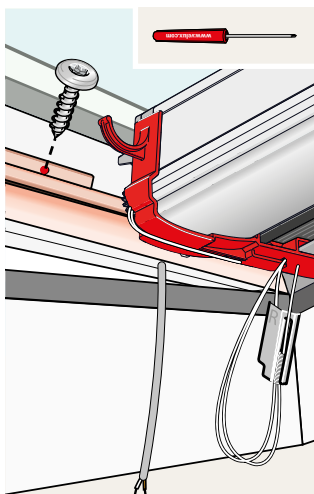
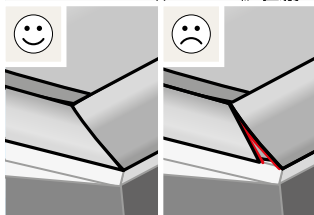
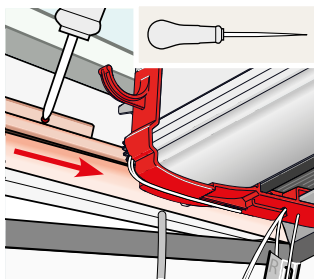
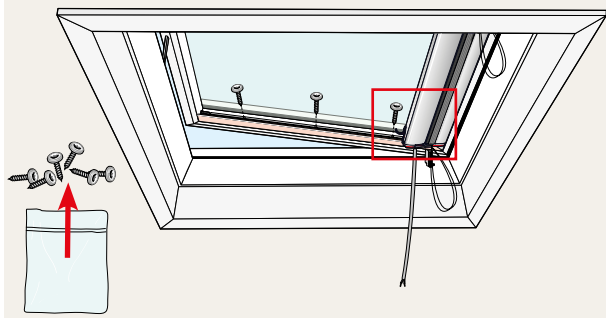

11

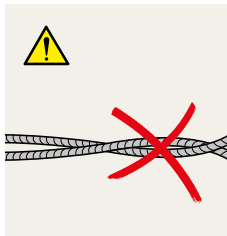
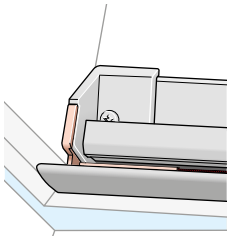
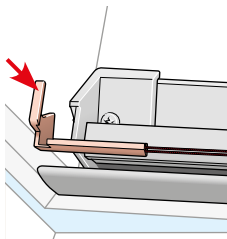
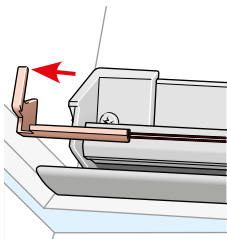
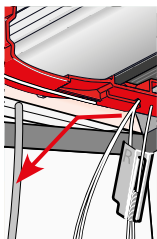
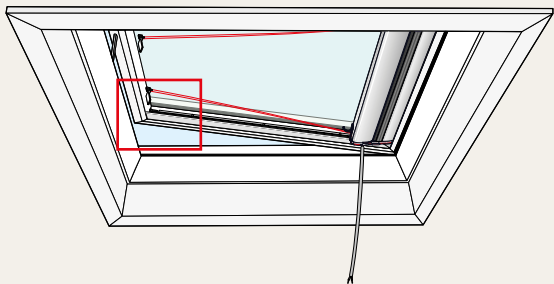

12

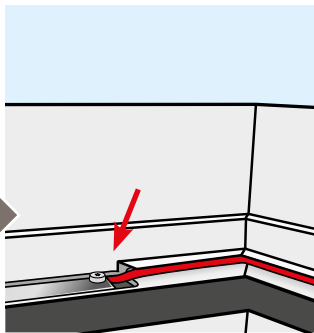
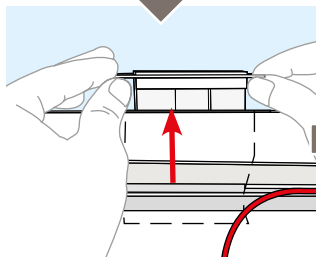
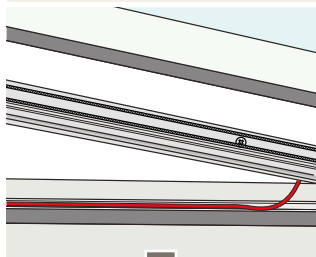
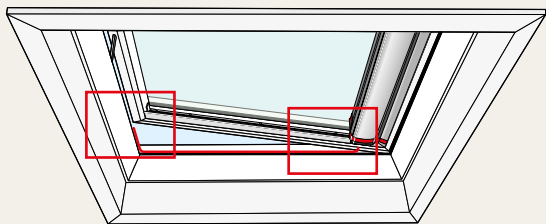

13

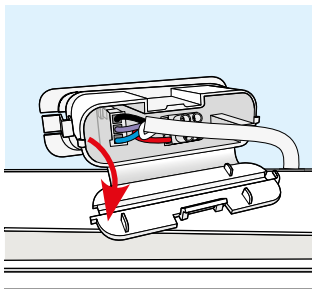
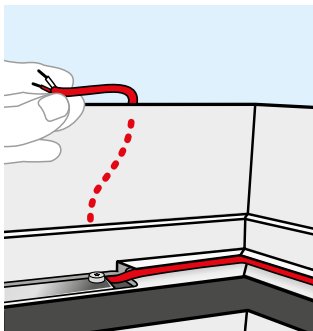
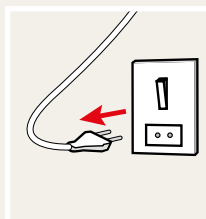
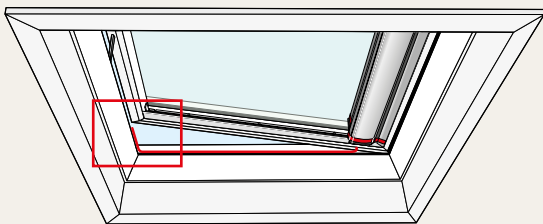

14

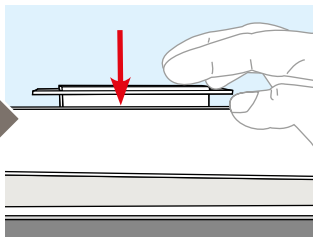
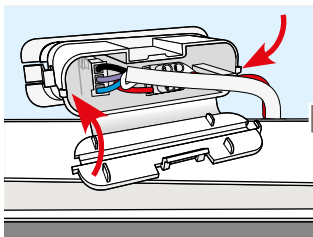
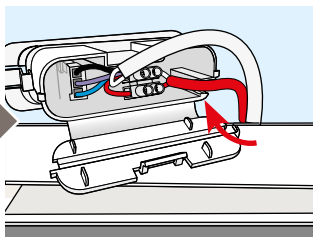
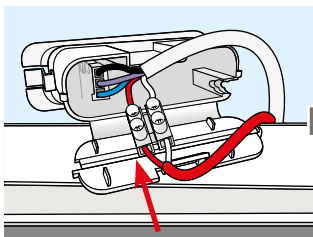
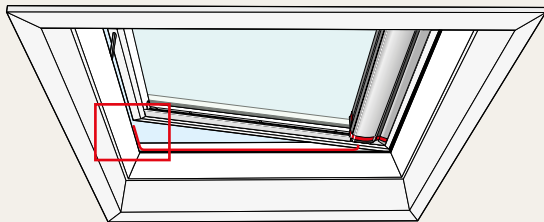

15

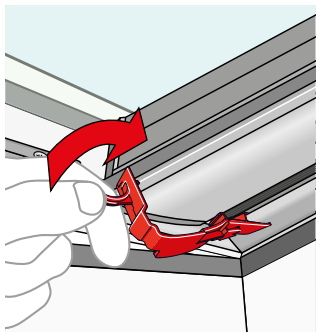
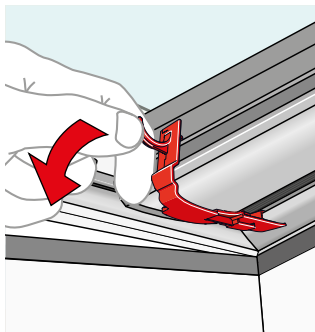
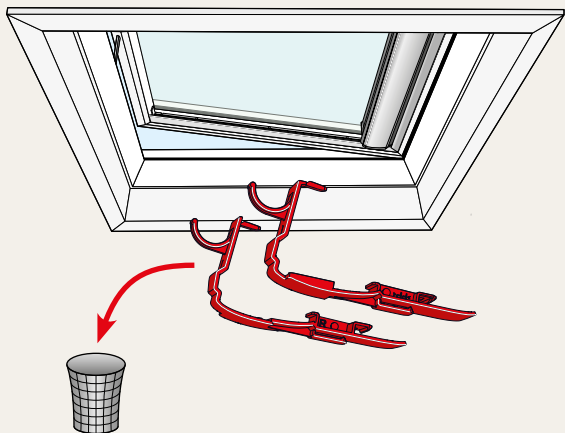

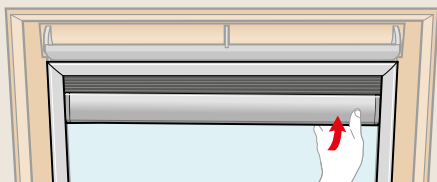
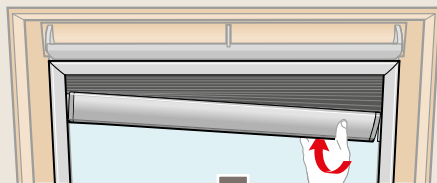
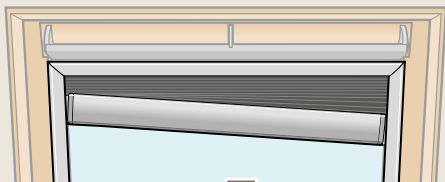
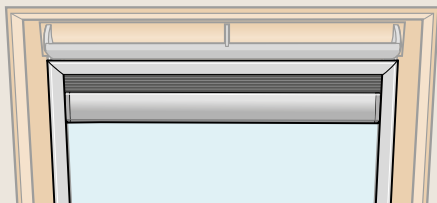

16

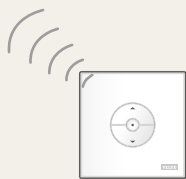
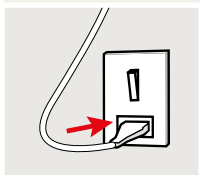
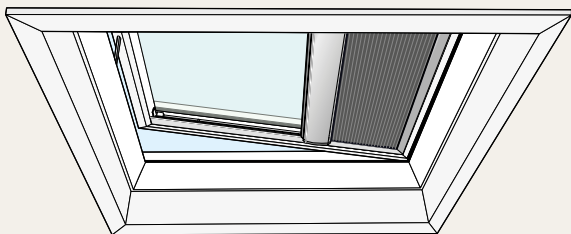

www.velux.com/electricalsupport



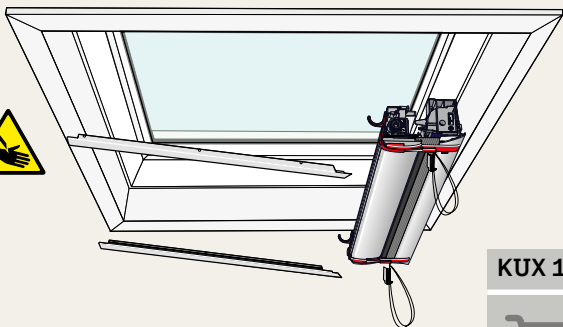

KUX 110

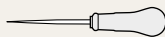
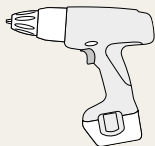
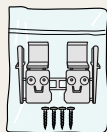
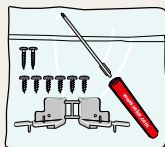
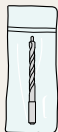
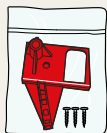

1

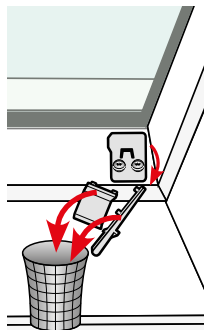
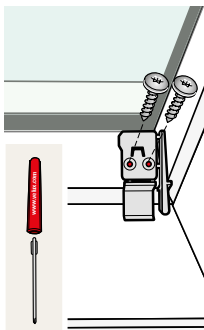
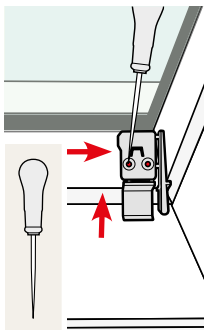
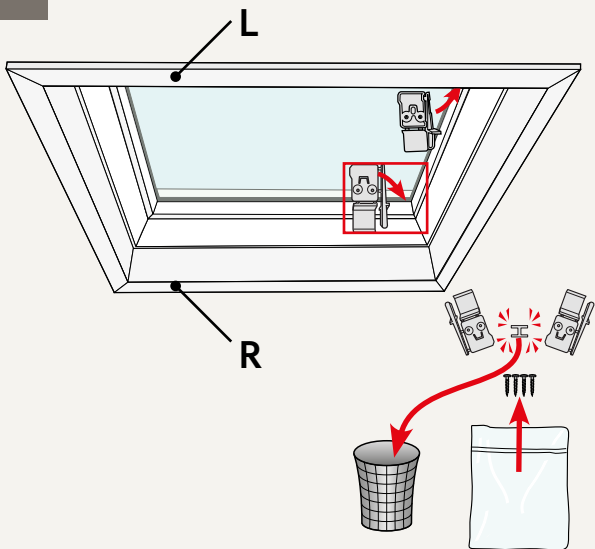

2

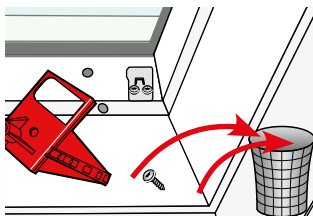
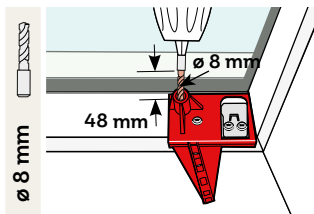
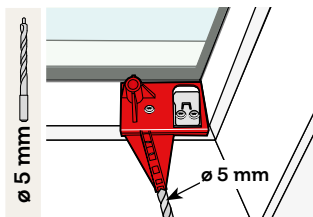
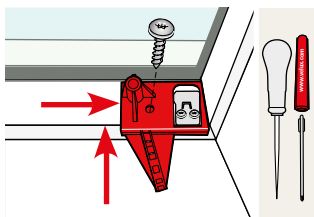
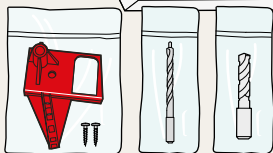
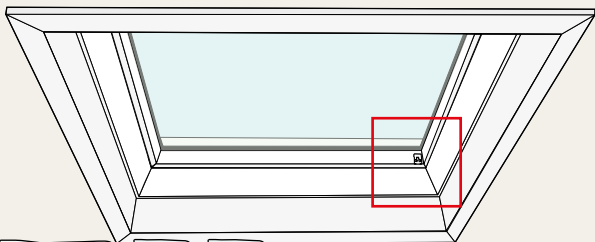

3

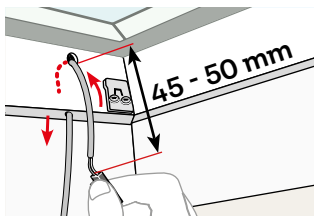
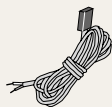
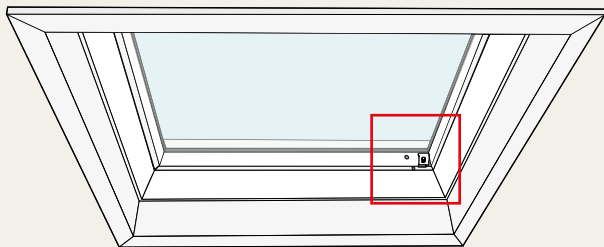

4

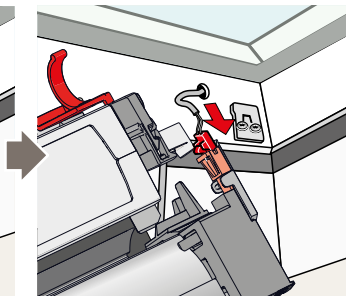
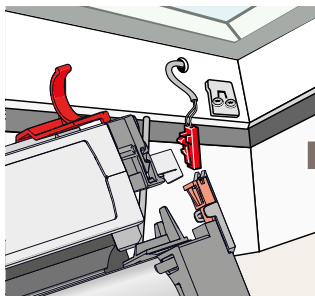
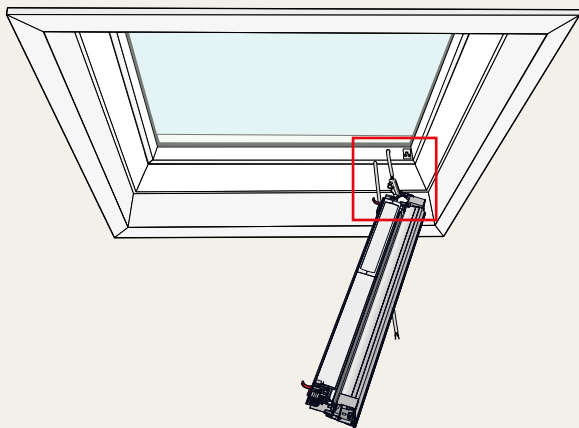

5

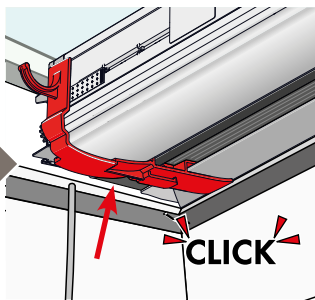
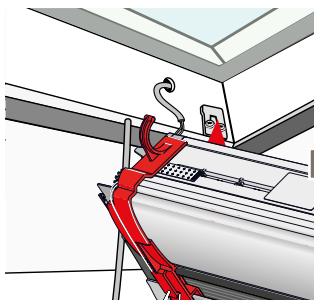
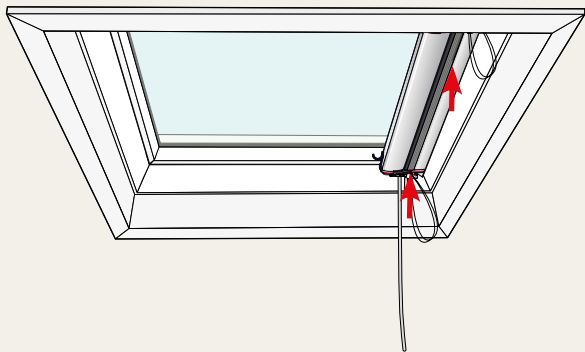

6

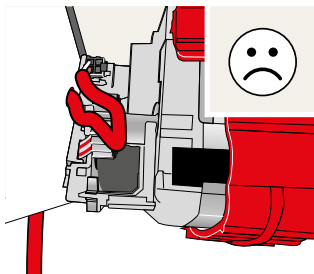
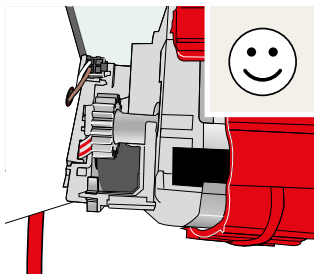
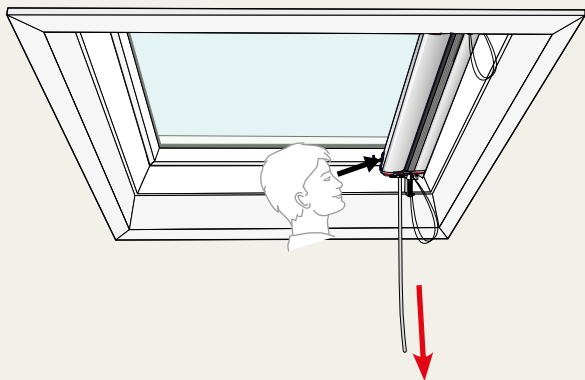

7

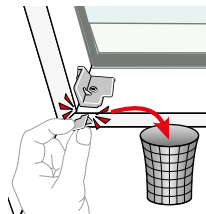
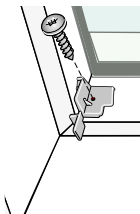
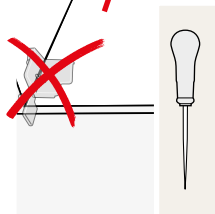
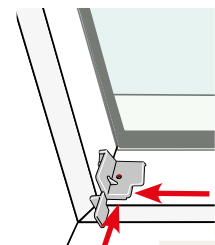
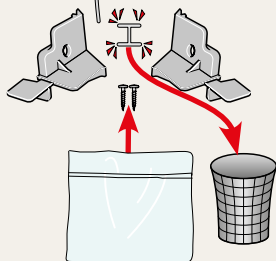
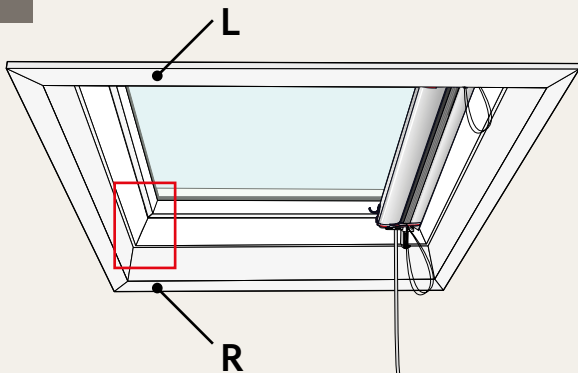

8

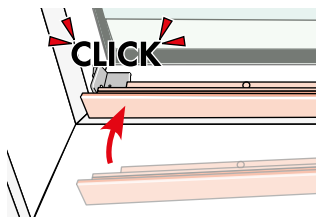
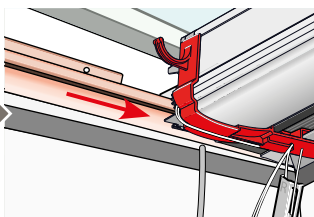
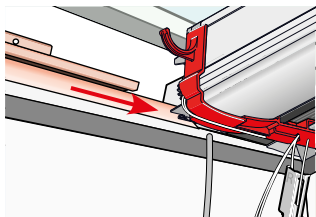
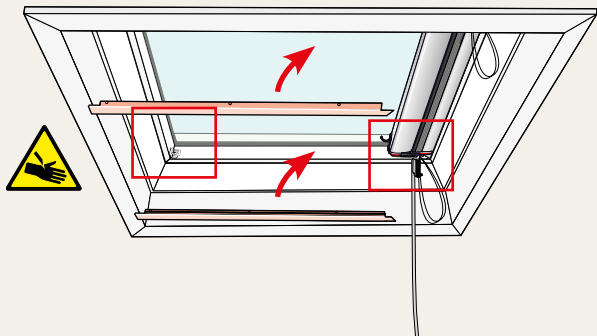

9

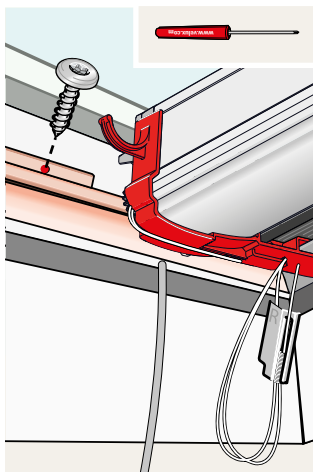
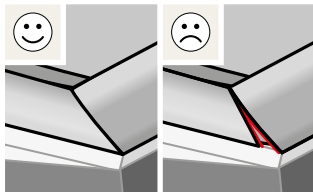
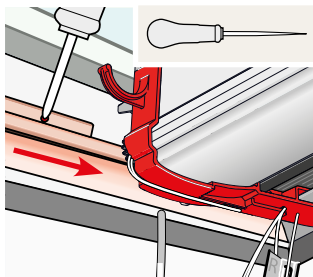
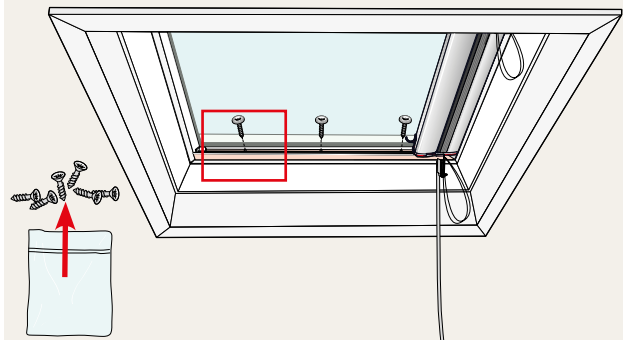

10

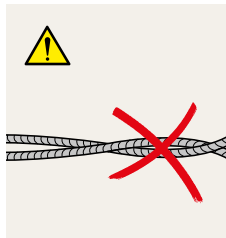
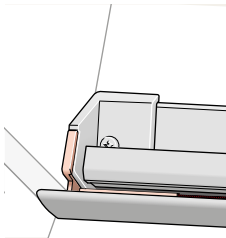
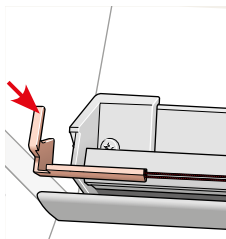
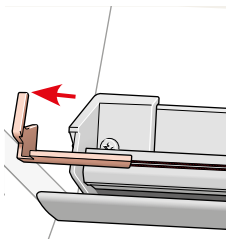
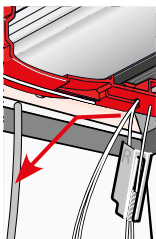
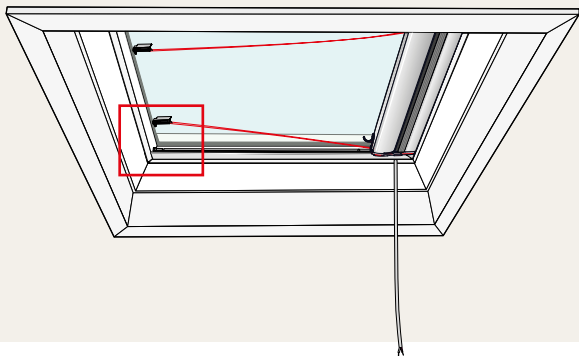

11

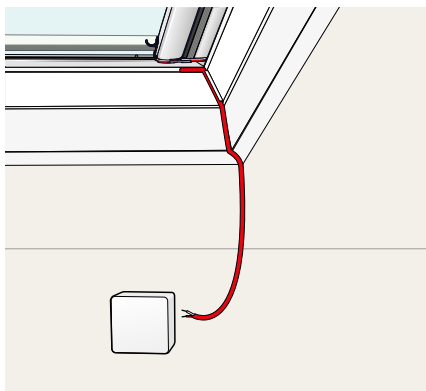
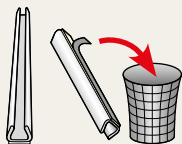
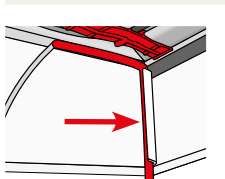
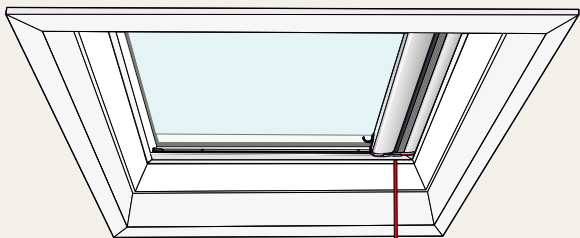

12

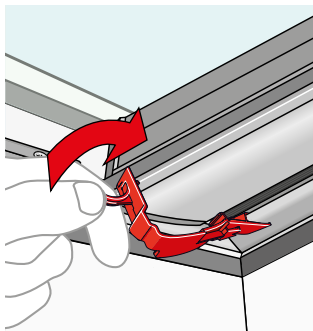
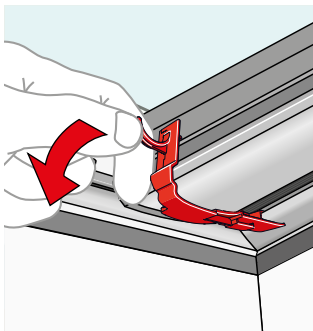
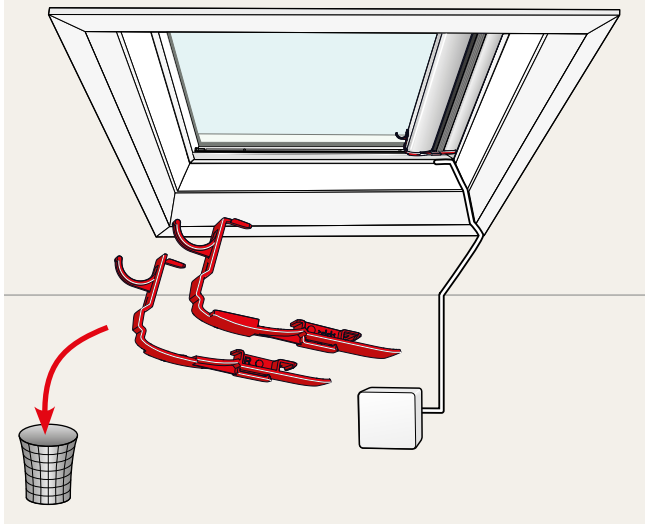

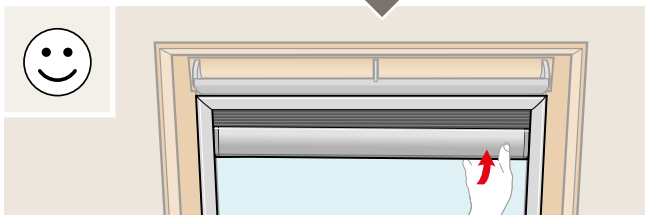
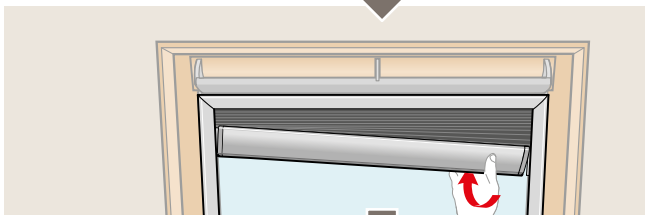
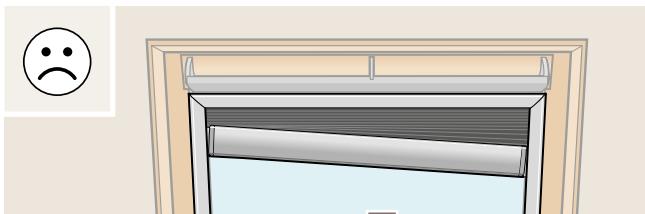
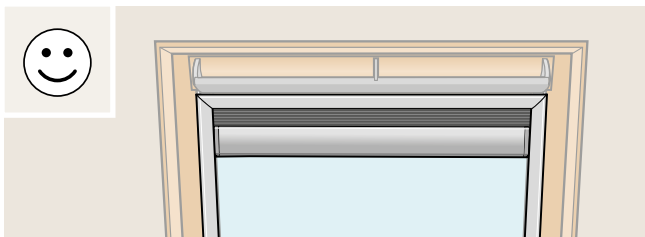

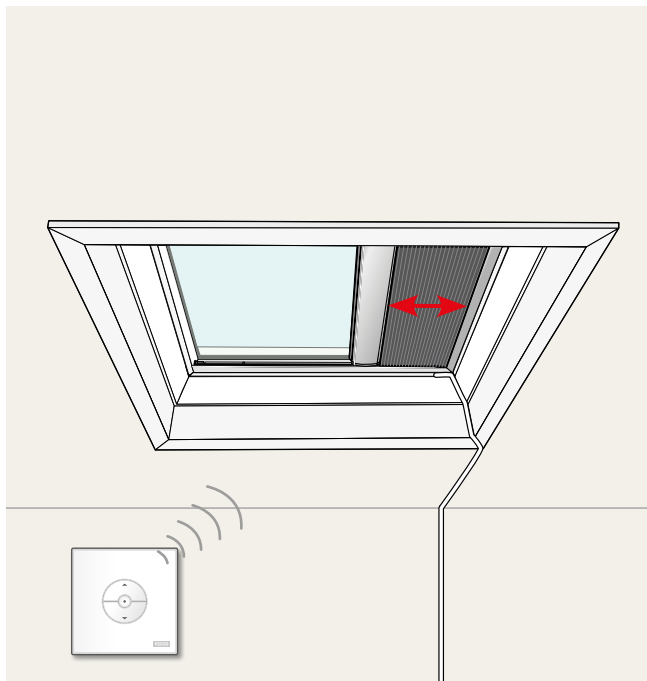

www.velux.com/electricalsupport

The block contains a square remote control and a VELUX instruction manual. The manual cover features the VELUX logo and the text 'VELUX® SKYLINE®' and 'VELUX® SKYLINE®'. Below the icons is the website address www.velux.com/electricalsupport.

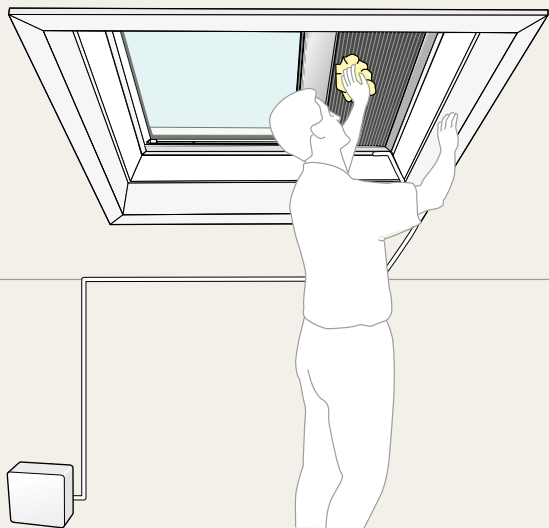

AR:	VELUX Export (VELUX A/S) + 45 4516 7885	IT:	VELUX Italia s.p.a. 045/6173666
AT:	VELUX Österreich GmbH 02245/32 3 50	JP:	VELUX-Japan Ltd. 0570-00-8141
AU:	VELUX Australia Pty. Ltd. 1300 859 856	KR:	VELUX Export (VELUX A/S) + 45 4516 7885
BA:	VELUX Bosna i Hercegovina d.o.o. 033/626 493, 626 494	LT:	VELUX Lietuva, UAB (85) 270 91 01
BE:	VELUX Belgium (010) 42.09.09	LV:	VELUX Latvia SIA 67 27 77 33
BG:	ВЕЛУКС България ЕООД 02/955 99 30	NL:	VELUX Nederland B.V. 030 - 6 629 629
CA:	VELUX Canada Inc. 1 800 88-VELUX (888-3589)	NO:	VELUX Norge AS 22 51 06 00
CH:	VELUX Schweiz AG 062 289 44 45	NZ:	VELUX New Zealand Ltd. 0800 650 445
CL:	VELUX Export (VELUX A/S) + 45 4516 7885	PL:	VELUX Polska Sp. z o.o. (022) 33 77 000 / 33 77 070
CN:	VELUX (CHINA) CO. LTD. 0316-607 27 27	PT:	VELUX Portugal, Lda 21 880 00 60
CZ:	VELUX Česká republika, s.r.o. 531 015 511	RO:	VELUX România S.R.L. 0268-402740
DE:	VELUX Deutschland GmbH www.velux.de/kontakt	RS:	VELUX Srbija d.o.o. 011 20 57 500
DK:	VELUX Danmark A/S 45 16 45 16	SE:	VELUX Svenska AB 042/20 83 80
EE:	VELUX Eesti OÜ 621 7790	SI:	VELUX Slovenija d.o.o. 01 724 68 68
ES:	VELUX Spain, S.A.U. 91 509 71 00	SK:	VELUX Slovensko, s.r.o. (02) 33 000 555
FI:	VELUX Suomi Oy 0207 290 800	TR:	VELUX Çati Pencereleri Ticaret Limited Şirketi 0 216 302 54 10
FR:	VELUX France 0806 80 15 15 Service gratuit + prix appel	UA:	ТОВ "ВЕЛЮКС Україна" (044) 2916070
GB:	VELUX Company Ltd. 01592 778 225	US:	VELUX America LLC 1-800-88-VELUX
HR:	VELUX Hrvatska d.o.o. 01/5555 444		
HU:	VELUX Magyarország Kft. (06/1) 436-0601		
IE:	VELUX Company Ltd. 01 848 8775		

www.velux.com